

Instruction Manual

737 555/Rev F/06-18

Safety

Please read this information carefully prior to installing or using this equipment.

1. The unit described in this manual is designed to be operated only by trained personnel. Any adjustments, maintenance and repair must be carried out as defined in this manual, by a person qualified to be aware of the hazards involved.
2. It is essential that both operating and service personnel employ a safe system of work, in addition to the detailed instructions specified in this manual.
3. Other than for those items defined in the maintenance procedures herein there are no user serviceable items in this instrument. Removal of covers and attempted adjustment or service by unqualified personnel will invalidate the warranty and may incur additional charges for repair.
4. References should always be made to the Health and Safety data supplied with any chemicals used. Generally accepted laboratory procedures for safe handling of chemicals should be employed. Do not use hazardous or flammable substances in the instrument.
5. If it is suspected that safety protection has been impaired in any way, the unit must be made inoperative and secured against any intended operation. The fault condition should immediately be reported to the appropriate servicing authority.
6. The warning symbol alerts the user to important information about using the instrument. Read and follow the associated instructions carefully.



7. **WARNING:** HIGH TEMPERATURES ARE DANGEROUS they can cause serious burns to operators and ignite combustible material.



8. This instrument uses a UV light source. Do not look directly at the light source.



9. **WARNING:** If the equipment is not used in the manner specified, the protection provided by the equipment may be impaired.
10. Do not replace the detachable mains leads with inadequately rated leads.

Merci de lire attentivement ces informations avant d'installer ou d'utiliser cet appareil.

1. L'appareil décrit dans ce manuel est conçu pour être utilisé uniquement par des personnes formées. Tout réglage, maintenance ou réparation doit être effectué comme décrit dans ce manuel, par une personne qualifiée consciente des risques encourus.
2. Il est essentiel que les personnes utilisant et intervenant sur cet appareil respectent les règles de sécurité de travail, en plus des instructions détaillées précisées dans ce manuel.
3. En-dehors des éléments décrits dans les procédures de maintenance ci-incluses, cet appareil ne contient aucun élément réparable par l'utilisateur. L'enlèvement des capots et les tentatives de réglage ou de réparation par des personnes non qualifiées invalide toute garantie et entraîne un risque de frais de réparation supplémentaires.
4. Toujours se référer aux fiches techniques de santé et de sécurité accompagnant tout produit chimique utilisé. Respecter les procédures de laboratoire généralement acceptées pour la manipulation en toute sécurité des produits chimiques. Ne pas utiliser de substances dangereuses ou inflammables sur l'appareil.
5. Si l'utilisateur suspecte qu'un problème quelconque puisse mettre en cause la sécurité, l'appareil doit être rendu inopérant en empêchant son utilisation. Communiquer la défaillance constatée au service de maintenance compétent.
6. Le symbole d'alerte signale à l'utilisateur les informations importantes concernant l'utilisation de l'appareil. Lire et suivre les instructions fournies avec la plus grande attention.



7. **AVERTISSEMENT:** Les **TEMPÉRATURES ÉLEVÉES SONT DANGEREUSES** car elles peuvent provoquer de graves brûlures chez l'opérateur et enflammer les matériaux combustibles.



8. Cet appareil utilise une source lumineuse UV. Ne pas regarder directement vers la source.

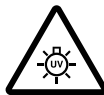

9. **ATTENTION.** Si l'appareil n'est pas utilisé de manière adéquate, la protection de l'appareil pourrait être impactée.
10. Ne pas remplacer le cordon d'alimentation fourni par un cordon d'alimentation de dimension électrique non adapté.

Bitte lesen Sie diese Hinweise vor Installation oder Gebrauch dieser Ausrüstung sorgfältig durch.

1. Das in diesem Handbuch beschriebene Gerät darf nur von geschultem Personal bedient werden. Alle Anpassungen, Wartungsarbeiten und Reparaturen müssen entsprechend der Vorgaben in diesem Handbuch und von einer kompetenten Person, die mit den damit verbundenen Gefahren vertraut ist, durchgeführt werden.
2. Es ist wichtig, dass sowohl das Bedienungs- als auch das Service-Personal zusätzlich zu den detaillierten Anweisungen in diesem Handbuch ein sicheres Arbeitssystem einsetzen.
3. Mit Ausnahme der Teile, deren Wartungsverfahren in diesem Handbuch beschrieben sind, enthält dieses Gerät keine weiteren Teile, die vom Benutzer gewartet werden können. Das Entfernen von Abdeckungen und Versuche von hierfür unqualifiziertem Personal, Anpassungen oder Wartungsarbeiten durchzuführen, haben zur Folge, dass die Garantie verfällt und können zusätzliche Reparaturkosten auslösen.
4. Es ist jederzeit auf die sicherheitsrelevanten Daten sämtlicher verwendeter Chemikalien Bezug zu nehmen. Allgemein anerkannte Labormethoden zum sicheren Umgang mit Chemikalien sollten eingesetzt werden. Verwenden Sie keine gefährlichen oder entzündlichen Stoffe in Verbindung mit dem Gerät.
5. Besteht der Verdacht, dass die Sicherheitsvorrichtungen in irgendeiner Weise beschädigt wurden, muss das Gerät außer Betrieb genommen und gegen weiteren Gebrauch gesichert werden. Die Störung sollte der zuständigen Serviceeinrichtung unverzüglich gemeldet werden.
6. Das Warnsymbol weist auf wichtige Informationen zur Verwendung des Geräts hin. Lesen und befolgen Sie die dazugehörigen Anweisungen sorgfältig.



7. **ACHTUNG: HOHE TEMPERATUREN STELLEN EINE GEFAHRENQUELLE DAR.** Sie können schwere Brandverletzung verursachen und brennbare Stoffe entzünden.



8. Dieses Instrument greift auf eine UV-Lichtquelle zurück. Nicht direkt in die Lichtquelle schauen.



9. **ACHTUNG:** Wenn das Gerät nicht in der vorgegebenen Weise eingesetzt wird, können die Schutzfunktionen des Gerätes beeinträchtigt werden.
10. Abnehmbares Anschlusskabel nicht durch unangemessen bewertete Kabel austauschen.

Leggere attentamente queste istruzioni prima di installare o utilizzare il dispositivo.

1. L'unità descritta nel presente manuale è stata realizzata per essere utilizzata solo da personale che ha ricevuto l'apposita formazione. Qualsiasi operazione di regolazione, manutenzione e riparazione deve essere effettuata sulla base di quanto indicato nel presente manuale da personale qualificato consapevole dei rischi connessi.
2. È fondamentale che il personale operativo e il personale addetto alla manutenzione utilizzino un sistema di lavoro sicuro, oltre a seguire le istruzioni specificate nel presente manuale.
3. Oltre a quelli indicati nelle procedure di manutenzione, all'interno di questo dispositivo non sono presenti altri elementi sui quali è possibile effettuare interventi. La rimozione delle protezioni e qualsiasi tentativo di regolazione o di manutenzione posto in essere da personale non qualificato invaliderà la garanzia. In questi casi, sarà necessario pagare un importo per le riparazioni effettuate.
4. È sempre necessario fare riferimento ai dati sulla salute e sulla sicurezza forniti con le sostanze chimiche utilizzate. Adottare le procedure di laboratorio generalmente accettate per la gestione delle sostanze chimiche. Non utilizzare sostanze pericolose o infiammabili sullo strumento.
5. Nel caso in cui si sospetti che la salute possa essere pregiudicata in qualsiasi modo, disattivare l'unità per renderla inutilizzabile. Qualsiasi condizione di errore deve essere immediatamente segnalata al responsabile per la manutenzione.
6. Il simbolo di avvertenza informa l'utente sulle informazioni importanti in merito all'uso dello strumento. Leggere e seguire le istruzioni corrispondenti con cura.



7. **AVVERTENZA:** Le ALTE TEMPERATURE SONO PERICOLOSE in quanto possono provocare serie ustioni agli operatori e dare fuoco al materiale combustibile.



8. Questo strumento utilizza una sorgente di luce UV. Non guardare direttamente la sorgente di luce.



9. **AVVERTENZA:** qualora il dispositivo non venga utilizzato nel modo descritto, la protezione fornita dal dispositivo stesso potrebbe risultare compromessa.
10. Non sostituire i cavi di alimentazione di rete scollegabili con cavi inadeguati.

Lea esta información atentamente antes de instalar o utilizar este equipo.

1. La unidad descrita en este manual está diseñada para que solamente la utilice personal con formación. Cualquier operación de ajuste, mantenimiento y reparación debe llevarse a cabo del modo indicado en este manual y debe realizarla una persona cualificada que sea consciente de los peligros que implica.
2. Es fundamental que tanto los operarios como el personal de servicio utilicen un sistema de trabajo seguro, así como las instrucciones detalladas que se especifican en este manual.
3. Cualquier elemento que no se encuentre entre los definidos en los procedimientos de mantenimiento aquí descritos no podrá utilizarse en este instrumento. La extracción de las tapas y los intentos de ajuste o reparación por parte de personal no cualificado invalidarán la garantía y pueden incurrir en cargos adicionales por reparación.
4. Siempre deberían consultarse los datos sobre Salud y Seguridad que se suministran con cualquier producto químico que se utilice. Es necesario llevar a cabo los procedimientos de laboratorio de aceptación generalizada para la manipulación segura de productos químicos. No utilice sustancias peligrosas o inflamables en el instrumento.
5. Si existe la sospecha de que las medidas protectoras de seguridad han quedado dañadas en cualquier modo, la unidad debe inutilizarse y protegerse contra toda operación que se intente llevar a cabo. El estado de fallo debe comunicarse inmediatamente a la autoridad de servicio de mantenimiento y reparación pertinente.
6. El símbolo de advertencia avisa al usuario de información importante relacionada con el uso del instrumento. Lea atentamente y siga las instrucciones correspondientes.



7. **ADVERTENCIA: LAS ALTAS TEMPERATURAS SON PELIGROSAS**, ya que pueden ocasionar quemaduras graves a los operarios y prender el material combustible.



8. Este instrumento utiliza una fuente de luz UV. No mire directamente a la fuente de luz.



9. **ADVERTENCIA:** Si el equipo no se utiliza de la manera especificada, la protección que ofrece el aparato puede verse afectada.
10. No sustituya el cable de alimentación eléctrica con cables de voltaje inadecuado.

Contents

SECTION 1 - INTRODUCTION	9
1.1 INSTRUMENT DESCRIPTION	9
1.2 IMPORTANT SAFETY ADVICE	9
1.3 GENOVA NANO WITH MICRO VOLUME ACCESSORY SPECIFICATION.....	10
1.4 UNPACKING	10
SECTION 2 – ACCESSORY LAYOUT AND INSTALLATION	11
2.1 ACCESSORY LAYOUT	11
2.2 INITIALISATION	11
Note: The instrument will return to the last main menu used	11
SECTION 3 – MICRO-VOLUME SETTINGS	12
3.1 ACCESSING THE MICRO VOLUME SETTINGS	12
3.2 PATH LENGTH SELECTION	13
3.2.1 Known Path Length Measurements	13
3.2.2 Unknown Path Length Measurements	13
3.2.3 Auto Path Length Availability.....	13
SECTION 4 – PERFORMING MICRO VOLUME MEASUREMENTS	14
4.1 PIPETTING SAMPLES ONTO THE MICRO VOLUME READ HEAD	14
4.2 SAMPLE RECOVERY OR REMOVAL	15
SECTION 5 – TOP 10 TIPS FOR SAMPLE MEASUREMENT	16
SECTION 6 – STEP BY STEP GUIDE TO MAKING A DNA MEASUREMENT	17
6.1 dsDNA Mode.....	17
6.2 A260/280 Mode.....	17
6.3 Multi-wavelength Mode	18
SECTION 7 – CALIBRATION OF THE MICRO VOLUME ACCESSORY	19
7.1 CALIBRATION SOLUTIONS (035 092)	19
7.2 MICRO VOLUME CALIBRATION PROCEDURE	19
7.2.1 Micro Volume Settings.....	19
7.2.2 Calibration Standard - Data Entry.....	19
7.2.3 Calibration and Verification.....	20
SECTION 8 – CLEANING AND DECONTAMINATION	26
8.1 CLEANING	26
8.2 DECONTAMINATION	26
8.3 READ HEAD RECONDITIONING.....	26
SECTION 9 – ACCESSORIES	27
9.1 ACCESSORIES	27
SECTION 10 – MAINTENANCE AND SERVICE	27
10.1 ROUTINE MAINTENANCE	27
10.2 SERVICE.....	27
10.3 WARRANTY.....	27

SECTION 7 – CALIBRATION OF THE MICRO VOLUME ACCESSORY	28
11.1 CALIBRATION ERROR CODES.....	28
11.1.1 Calibration Procedure Error Codes.....	28
11.2 TROUBLESHOOTING GUIDE.....	28
11.3 TECHNICAL SUPPORT.....	28
SECTION 12 – GLOSSARY OF ICONS	29
SECTION 13 – CHEMICAL COMPATIBILITY	30
SECTION 14 – DECLARATION OF CONFORMITY	31

SECTION 1 - INTRODUCTION

1.1 INSTRUMENT DESCRIPTION

The Genova Nano is a UV/visible spectrophotometer dedicated to life science analysis. This spectrophotometer incorporates a micro volume sample measurement accessory that allows sample volumes as low as 0.5µl to be analysed. In addition to the standard measurement modes: photometrics, concentration, multi-wavelength, spectrum scanning, quantitation and kinetics, the Genova Nano spectrophotometer is pre-programmed with methods to determine DNA concentration and purity ratios using wavelengths recorded at 260, 280 and 230nm, with an optional correction at 320nm. In addition there are pre-programmed methods for protein analysis such as the Bradford, Lowry, Biuret, BCA and Direct UV methods.

This life science spectrophotometer uses icon driven software and has an improved navigation system for easy and intuitive usability.

This equipment is designed to operate under the following conditions:

- ❖ For indoor use only
- ❖ Use in a well ventilated area
- ❖ Ambient temperature range 5°C to 40°C (41°F to 104°F)
- ❖ Altitude to 2000 m (6500 ft)
- ❖ Relative humidity not exceeding 80%
- ❖ Mains supply fluctuations not exceeding 10% of nominal
- ❖ Overvoltage category II IEC60364-4-443
- ❖ Pollution degree 2 IEC664
- ❖ Use with a minimum distance all round of 200 mm (8 in.) from walls or other items

1.2 IMPORTANT SAFETY ADVICE

- ❖ **SHOCK HAZARDS OR UNSAFE PRACTICES ARE DANGEROUS** as they can cause severe personal injury, fire or death.
- ❖ **DO NOT** use combustible substances near hot objects.
- ❖ **DO NOT** use the equipment in hazardous atmospheres.
- ❖ **DO NOT** operate or handle any part of the product with wet hands or use on surfaces that may become flooded.
- ❖ **NEVER** move the product while still connected to the power supply.
- ❖ **HIGH TEMPERATURES ARE DANGEROUS** as they can cause serious burns to operators and ignite combustible material.
- ❖ **USE CARE AND WEAR PROTECTIVE GLOVES TO PROTECT HANDS.**
- ❖ **NEVER** lift or carry the instrument until it has been switched off and allowed to cool.
- ❖ **DO NOT** position the unit so that it is difficult to disconnect from the mains supply using the mains plug.
- ❖ The mains outlet socket used should be located close to the equipment and readily identifiable and accessible to users.
- ❖ **DO NOT** leave equipment switched on and it is not recommended to leave any heating apparatus unattended during operation.
- ❖ The unit should be carried using both hands.

1.3 GENOVA NANO WITH MICRO VOLUME ACCESSORY SPECIFICATION

Wavelength	
Range	198 to 1000nm
Resolution	
Accuracy	± 2nm
Repeatability	± 0.5nm
Spectral bandwidth	5nm

Photometrics	
Absorbance Range	-0.300 to 2.500A (10mm path length equivalent = -15.0 to 125.0A)
Accuracy	±2% @ 1A
Absorbance Precision	Between 0 and 1A = <0.005, 1 to 2A = 2%, above 2A = 4%.
dsDNA Detection	2.0 ng/μl
Limit (0.5mm)	
dsDNA Maximum	6000 ng/μl
Concentration	
(0.2mm)	
Stray light	<0.5% at 340nm and 220nm

Other	
Power	24V 2.7A 65W
Size (w x d x h)	275 x 400 x 220mm
Weight	7.7kg
Path lengths	0.2mm and 0.5mm
Measurement time	<6.5s
Sample size	0.5 to 5.0μl
Operating Temperature	10 to 40°C
Operating Humidity	0 to 80% non-condensing

1.4 UNPACKING

Please check that the following items are included in the packaging:

- Genova Nano spectrophotometer (737 503)
- 4GB USB memo y stick (019 146)
- Universal power supply 24V, 65W (021 060)
- Calibration standards with certificate (035 092)
- Genova Nano instruction manual (737 555)
- Genova Plus instruction manual (736 505)

The Genova Nano is delivered with the micro volume accessory securely packaged in the spectrophotometers sample chamber.

Note: The protective packaging must be removed before the instrument is first initialised.

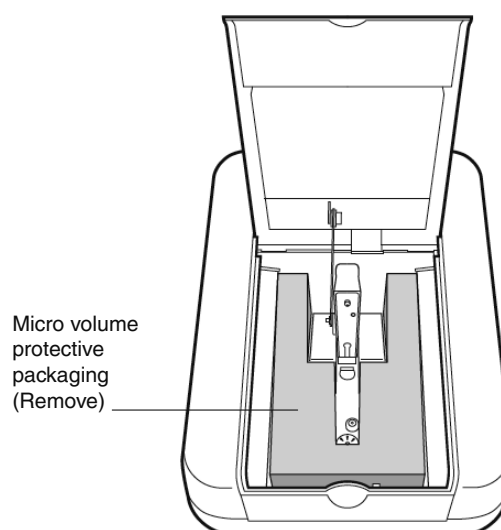

Fig 1.3 - Micro Volume Accessory Unpacking

SECTION 2 – ACCESSORY LAYOUT AND INSTALLATION

2.1 ACCESSORY LAYOUT

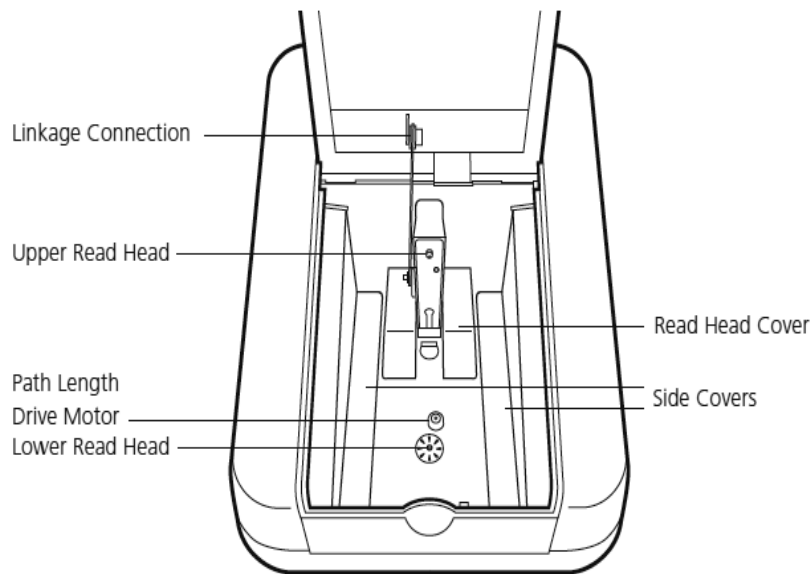

Fig 2.1 – Micro Volume Accessory Layout

2.2 INITIALISATION

Connect the power supply unit to the power inlet socket on the rear panel of the instrument and connect to the mains socket. Turn the power on at the mains and switch the instrument on using the power switch on the rear of the instrument.

The instrument will initially check for firmware updates and then perform several power-on tests before displaying the main menu:

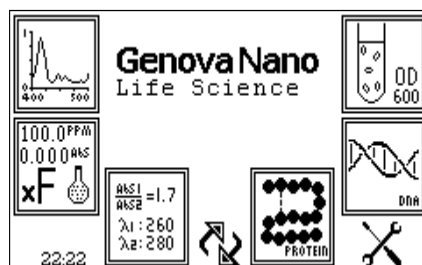

Fig 2.2 – Genova Nano Main Menu

Note: The instrument will return to the last main menu used.

SECTION 3 – MICRO-VOLUME SETTINGS

3.1 ACCESSING THE MICRO VOLUME SETTINGS

The **Micro Volume** icon is displayed in the bottom right hand corner of the screen in each measurement mode.

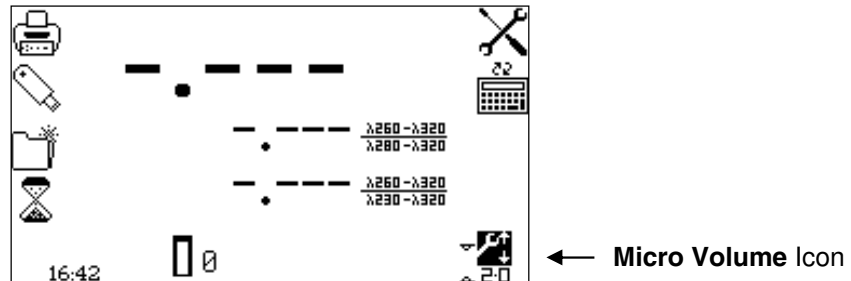

Fig 3.1 – Accessing the Micro Volume Settings Menu

The micro volume settings are accessed by pressing the key below the **Micro Volume** icon.

The micro volume settings allow the user to select the required path length (0.2mm or 0.5mm) for a measurement and to calibrate the accessory using a standard solution with known absorbance values at 260 and 330nm.

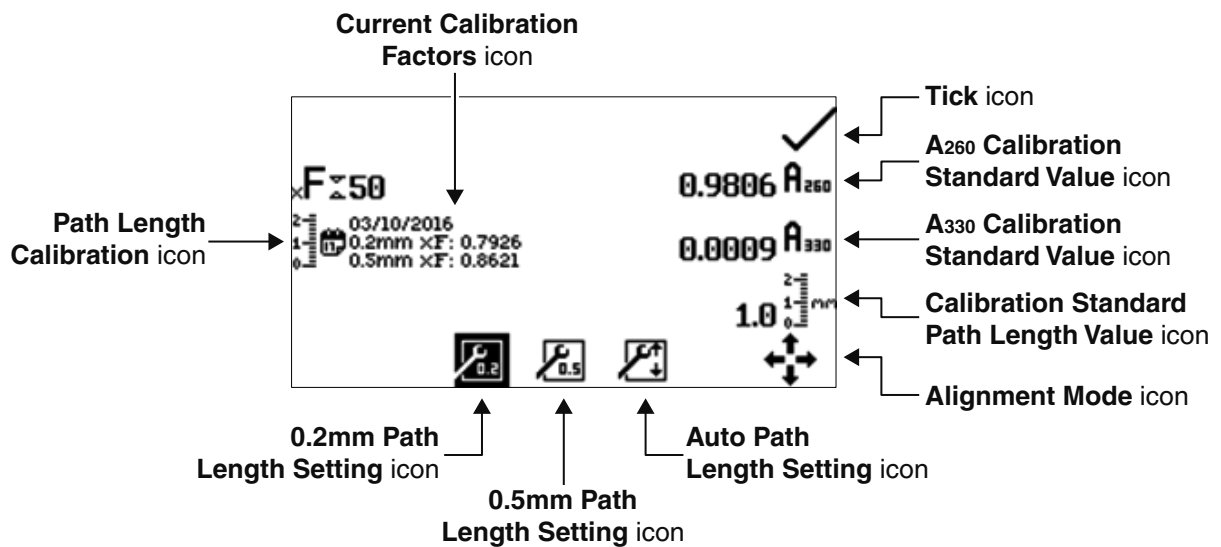
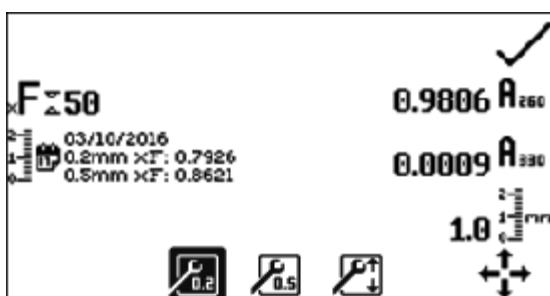

Fig 3.2 – Micro Volume Settings Menu

3.2 PATH LENGTH SELECTION

3.2.1 Known Path Length Measurements



If the required measurement path length is known it can be selected by pressing the button adjacent to the **0.2mm or 0.5mm Path Length Setting** icons. The selected setting is indicated by an icon with a black background. Once the required path length setting has been selected press the button adjacent to the **Tick** icon to confirm.

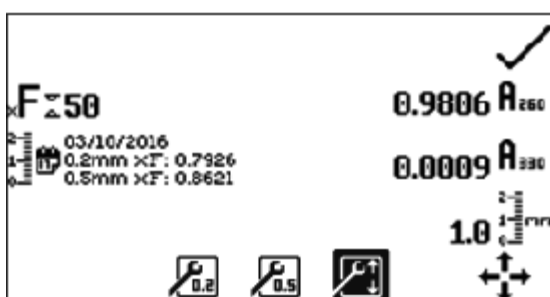

If the required measurement path length is not known in selected modes the auto path length setting can be selected by pressing the button adjacent to the **Auto Path Length Setting** icon. Once the auto path length setting has been selected press the button adjacent to the **Tick** icon to confirm.

The auto path length measurement setting will firstly measure a sample using the 0.5mm path length setting. If the measured photometric value is within range, the value will be displayed on screen and no more measurements are taken. If however the measured value is over-range, the sample will be re-measured using the 0.2mm path length setting.

3.2.3 Auto Path Length Availability

Mode	Auto path length availability
Photometrics	Available
Spectrum, purity scan	Not available
Concentration, concentration plus	Available
Kinetics	Not available
Multi wavelength, multi wavelength plus	Available
Quantitation	Not available
Protein (quantitative assay modes)	Not available
Protein (direct UV)	Available
DNA (all modes)	Available
OD 600	Available

SECTION 4 – PERFORMING MICRO VOLUME MEASUREMENTS

For detailed descriptions of the measurement modes that are available on the Genova Nano spectrophotometer please refer to the supplied Genova Plus operating manual.

4.1 PIPETTING SAMPLES ONTO THE MICRO VOLUME READ HEAD

The Genova Nano spectrophotometer is designed to measure sample volumes ranging from 0.5µl to 5.0µl.

Jenway recommends that users should, if possible, use at least 2µl of sample for their measurements.

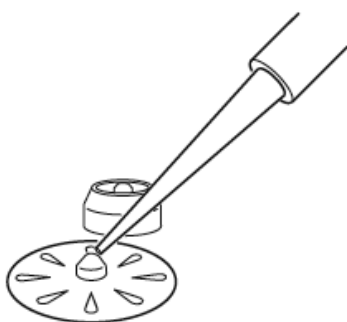

1. With the read head mechanism open, pipette the liquid to be analysed onto the centre of the lower read head. Ensure there are no bubbles in the sample.

Pipetting a sample onto the read head

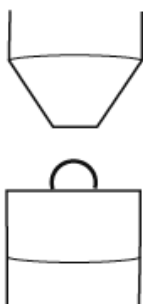

Read head in rest position

2. Close the lid of the spectrophotometer. This will lower the read head assembly down onto the path length drive motor. The upper read head will now be in the rest position, 2mm above the lower read head.

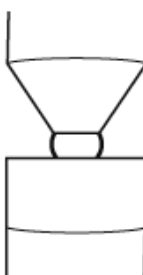

Read head in measurement position

3. When a measurement is initiated, the path length drive motor lowers the upper read head to the specified measurement distance, the photometric measurement is taken and the upper read head is then returned to the rest position.

4.2 SAMPLE RECOVERY OR REMOVAL

Once a measurement is complete, the sample solution can be recovered from the lower read head with a suitable pipette or removed from the read heads by cleaning with a suitable lint free cloth.

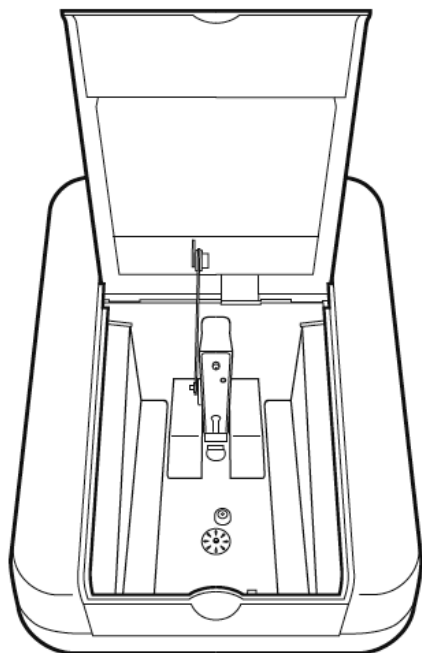

1. Open the lid of the spectrophotometer. The read head mechanism will open to allow access to the upper and lower read heads

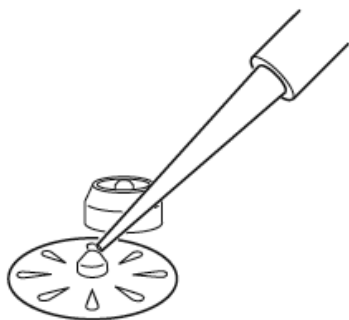

2. The sample can be recovered by carefully drawing the liquid that is retained on the lower read head into a clean pipette tip.
3. Both read heads should then be wiped with a lint free cloth.

4. More rigorous cleaning may be required after the measurement of high concentration samples or samples that pose a contamination risk. See section 8 for further details.

SECTION 5 – TOP 10 TIPS FOR SAMPLE MEASUREMENT





1. Ensure the read heads are clean. Wipe both the upper and lower read heads with a lint-free cloth wetted with deionised water to remove any residues of previous samples. Dry with a fresh cloth.
2. If a stable droplet does not form, “buff” the read head surfaces by rubbing aggressively with a dry laboratory wipe 30-40 times. This will “re-condition” the surface.
3. Make sure that the sample is well mixed and free of air bubbles or particles. If a bubble is created when pipetting the sample, remove the sample and repeat the application.
4. If possible use at least 2µl of sample for measurement. When measuring at 0.2mm path length, a minimum of 0.5µl can be used.
5. Read each sample droplet only once. The read head moves into a default position after the sample has been measured. This means that if the sample is measured a second time, contact of the droplet with the read heads could be lost and the subsequent reading will not give a valid result.
6. Use a sample of sufficient concentration. Remember that the short path length creates a “virtual dilution” of the sample of 1 in 20 at 0.5mm and 1 in 50 at 0.2mm. This means that a sample which would normally read an absorbance of 1.0 in a standard 10mm cuvette will only give a value of 0.05 at 0.5mm or 0.02 at 0.2mm.
7. To minimise any factors which may interfere with a reading such as sample turbidity or contaminants carried over from sample preparation, it is recommended that a background reading is also made at a second reference wavelength (where the absorbance of the sample is very low and unchanging). In the nucleic acid and protein direct UV modes this option is defaulted to ON at a wavelength of 320nm; this can be deactivated if required.
8. Use the same measurement mode if comparing the concentrations of samples. Different modes use different equations to calculate the final sample concentration.
9. Be aware that when measuring micro volume samples, very small changes in absorbance can lead to much greater differences in calculated concentration values due to the inherent “dilution” factor of the small path length. For example, when measuring dsDNA, an absorbance change of just 0.001 equates to a derived concentration change of 1µg/ml at 0.5mm path length (based on 1 A260 unit of dsDNA = 50µg/ml).
10. Jenway recommends that the micro volume accessory is calibrated every 6 months. A set of calibration solutions (Part code 035 092) are supplied with the Genova Nano spectrophotometer for this purpose. Full instructions are given in Section 7.

SECTION 6 – STEP BY STEP GUIDE TO MAKING A DNA MEASUREMENT

The DNA measurement mode of the Genova Nano allows the user to select a method from a list of common nucleic acid measurement tests, including single wavelength concentration measurements for dsDNA, ssDNA, RNA and Oligonucleotides and methods that use absorbance ratios for estimating nucleic acid purity, such as 260nm/280nm and 260nm/230nm. Section 14 of the Genova Plus manual gives further details of the DNA measurement modes.

6.1 dsDNA Mode

This mode simply multiplies the A260 reading by a factor of 50 for dsDNA to calculate the concentration in µg/ml. An additional factor for the path length is also included automatically by the instrument.



1. From the **Life Science** screen select the **DNA mode**: , followed by **dsDNA**.
2. Press the button next to the **Settings Menu** icon:  and check that the wavelength is set to 260nm, the units are µg/ml and F1 = 50.
3. Lift the lid of the Genova Nano and pipette 2µl of water onto the read head. Close the lid.
Perform the **Blank Reading**: .
4. Lift the lid and wipe the water from both the upper and lower read heads.
5. Pipette 2µl of the DNA sample onto the read head. Close the lid and perform the **Sample Reading**: . Record the results.

6.2 A260/280 Mode

This method uses the equation:

$$\text{Concentration } (\mu\text{g/ml}) = (\text{Abs}@260\text{nm} \times 62.9) - (\text{Abs}@280\text{nm} \times 36.0).$$



This equation takes into account any contamination present which may absorb at 280nm (e.g. protein).

1. From the **Life Science** screen select the **DNA mode**: , followed by **260/280**.
2. Press the button next to the **Settings Menu** icon: . Check that the settings are as follows: Wavelength 1: 260; Wavelength 2: 280; Wavelength 3: 230; units, µg/ml.
3. Touch the button next to the **Calculation Factors** icon:  and check that Factor 1 = 62.9; Factor 2 = 36.0; Sum,=(x F1*A1)-(x F2*A2).
4. Press the button next to the **Tick** icon twice to return to the measurement screen.

5. Lift the lid of the Genova Nano and pipette 2µl of water onto the read head. Close the lid. Perform the blank reading.
6. Lift the lid and wipe the water from both the upper and lower read heads.
7. Pipette 2µl of the DNA sample onto the read head. Close the lid and perform the DNA reading. Record the results.

6.3 Multi-wavelength Mode

This mode simply calculates the DNA concentration by multiplying by the factor 50 for dsDNA but also allows correction by a reference wavelength at 320nm.

1. From the Life Science screen select the **Multiwavelength mode:** 
2. Press the button next to the **Settings Menu** icon: . Check that the settings are as follows: Wavelength 1: 260; Wavelength 2: 280; Wavelength 3: 230. Activate the reference Wavelength 4, 320nm. The units are µg/ml.
3. Touch the button next to the **Calculation Factors** icon:  and check that Factor 1 = 50; Factor 2 = 0 and the Sum = (xF1*(A1-A4))-(xF2*(A2-A4)).
4. Press the button next to the **Tick** icon twice to confirm and return to the measurement screen.
5. Set the path length to 0.5mm. Press the button next to the **Tick** icon to confirm.
6. Lift the lid of the Genova Nano and pipette 2µl of water onto the read head. Close the lid. Perform the blank reading.
7. Lift the lid and wipe the water from both the upper and lower read heads.
8. Pipette 2µl of the DNA sample onto the read head. Close the lid and perform the DNA reading. Record the results.

SECTION 7 – CALIBRATION OF THE MICRO VOLUME ACCESSORY

Jenway recommends that the micro volume accessory is calibrated every 6 months. A set of calibration solutions (Part code 035 092) are supplied with the Genova Nano spectrophotometer. Please note that the calibration solutions should be discarded 1 week after being opened.

When using the calibration solutions we advise the use of chemically resistant gloves and goggles and that there is eye wash available immediately. We recommend safe handling of the calibration solution - avoid skin contact, direct inhalation or ingestion of the standards as advised in the MSDS.

7.1 CALIBRATION SOLUTIONS (035 092)

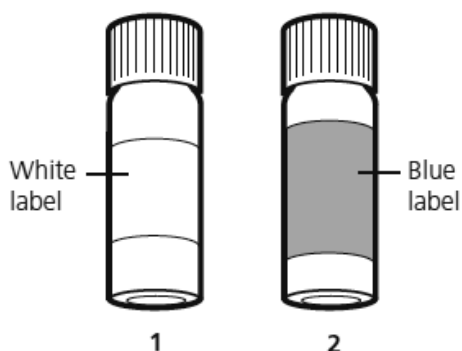

The supplied calibration solution set consists of two vials.

1. Matrix Blank (White)
2. 10x ref - Calibration Standard (Blue)

A calibration certificate is supplied that details the certified absorbance values of the calibration standard and the path length at which these values were determined.

7.2 MICRO VOLUME CALIBRATION PROCEDURE

7.2.1 Micro Volume Settings

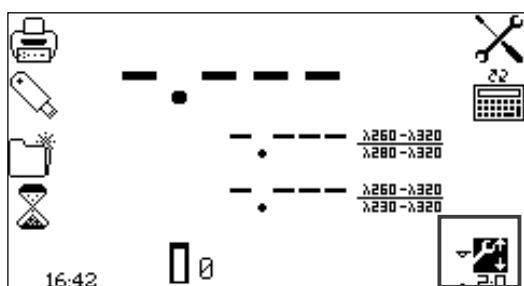

The micro volume settings can be accessed by pressing the key below the **Micro Volume** icon in any of the Genova Nano's operating modes.

7.2.2 Calibration Standard - Data Entry

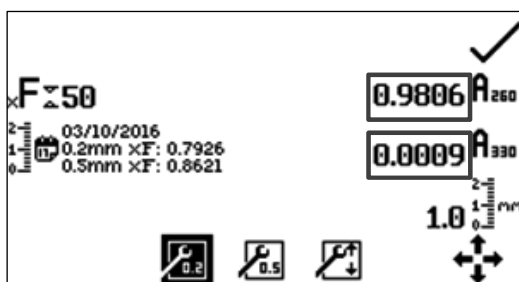

1. Enter the A260 and A330 DNA standard solution values given on the calibration certificate into the accessory settings by pressing the key adjacent to the **Calibration Standard Value** icon.

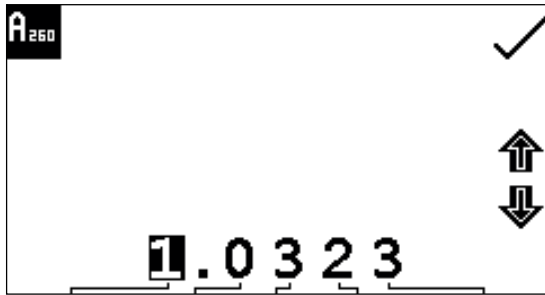

2. Select the digit to be changed using the keys at the bottom of the screen. Use the keys adjacent to the **Arrow** icons to increase or decrease the number. Press the key adjacent to the **Tick** icon to save any changes.

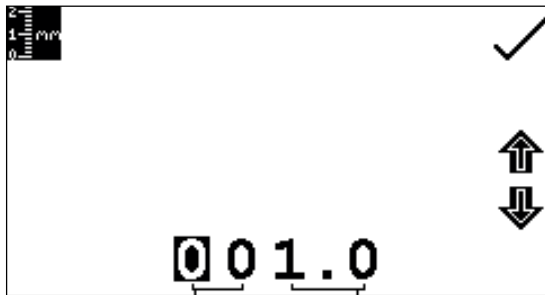

3. Enter the stated path length in mm (1.0mm for the supplied calibration standard solution set) for the DNACON standard solution into the accessory settings by pressing the key adjacent to the **Calibration Standard Path Length Value** icon.

4. Select the digit to be changed using the keys at the bottom of the screen. Use the keys adjacent to the **Arrow** icons to increase or decrease the number. Press the key adjacent to the **Tick** icon to save any changes.

7.2.3 Calibration and Verification

If an error message is displayed during the calibration and verification procedure, refer to Section 11 for further details.

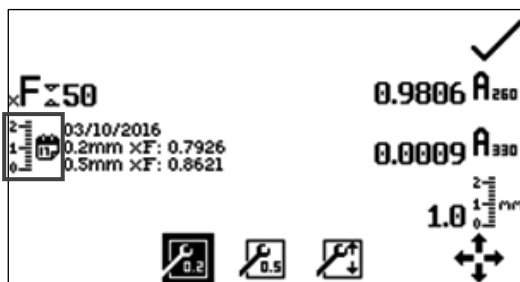

1. The calibration sequence is initiated by pressing the key adjacent to the **Path Length Calibration** icon.

2. The **Air Measurement** icon will be displayed. If a USB stick is inserted into the unit, a **Save** icon will also be displayed.

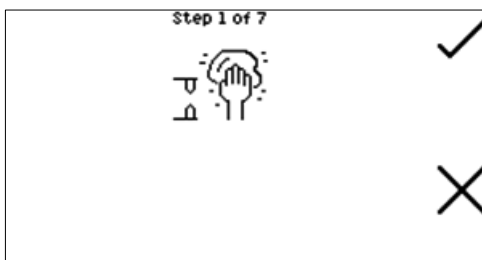

During the calibration process, there is the option to log the calibration data to USB stick. This generally isn't needed, but if you experience difficulties in performing a successful calibration you can forward the calibration log data to cptechsupport@coleparmer.com for further advice.

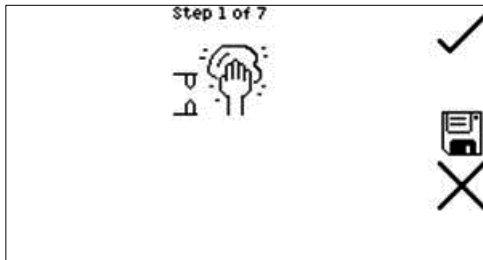

By default, the calibration data logging is disabled. To enable this function, press the key adjacent to the **Save** icon. The **Save** icon will become reversed to indicate that logging is enabled.



Pressing the key adjacent to the **Save** icon again will disable this feature. This can be enabled or disabled whenever the **Save** icon is displayed.

Use a lint free cloth to clean the upper and lower read heads, close the instrument lid and press the key adjacent to the **Tick** icon to continue. Pressing the key adjacent to the **Cross** icon will return the instrument to the micro volume settings menu screen.

The unit takes three dark and light readings at 260 and 330nm, at both 0.5mm and 0.2mm path lengths.

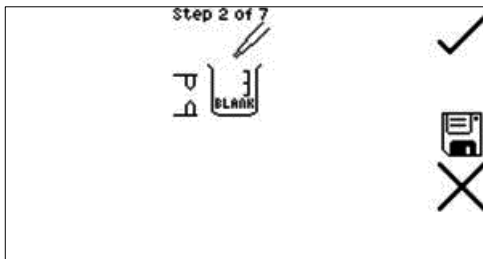

3. The **Blank Solution Measurement** icon will be displayed. Open the instrument lid and pipette a 2.0µl aliquot of the matrix blank solution onto the lower read head. Close the instrument lid and press the key adjacent to the **Tick** icon to initiate the blank measurement.

4. The unit takes three readings at 260 and 330nm, at both 0.5mm and 0.2mm path lengths. At the end of the readings, the unit will display the results of the measurements taken:

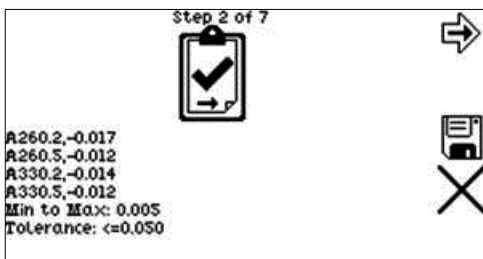

A260.5 indicates the Absorbance calculated at 260nm at 0.5mm path length. The criteria for a pass is that the spread of the absorbances across all four measured points is less than or equal to 0.050 Absorbance.

- If the measured values are within the required tolerances, the **Passes Test** icon will be displayed and a forwards arrow appears to allow the user to move on to measure the calibration solution. Press the button adjacent to the **Forwards Arrow** icon to continue or press the button adjacent to the **Cross** icon to abort the calibration process.

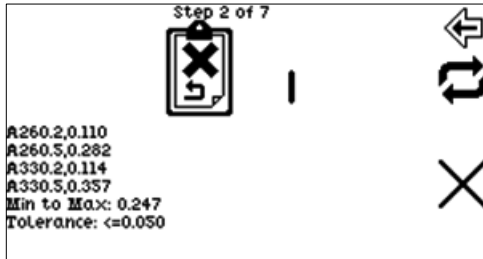

If the measured values are not within the required tolerances, the **Fails Test** icon is shown with an error number. Refer to section 11 for a list of error codes.

Press the button adjacent to the **Circular Arrow** icon to repeat the blank solution measurement or press the button adjacent to the **Back Arrow** icon to return to the air measurement screen.

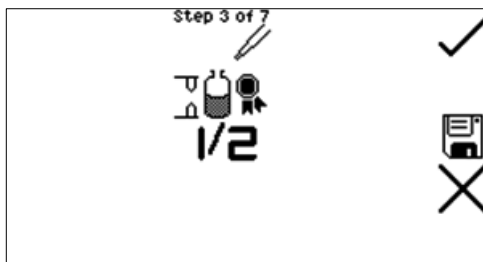

- The **Calibration Solution Measurement** icon will be displayed. Open the instrument lid and use a lint free cloth to clean the read heads.

- Pipette a 2.0µl aliquot of the calibration solution onto the lower read head. Close the instrument lid and press the key adjacent to the **Tick** icon to initiate the calibration solution measurement.
- The unit takes three readings at 260 and 330nm, at both 0.5mm and 0.2mm path lengths. At the end of the readings, the unit will display the results of the measurements taken:

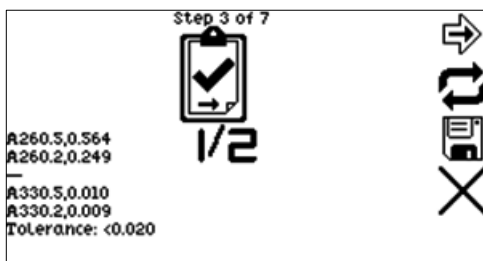

The readings at this stage are validated by examining the Absorbance at 330nm – used for background correction of the readings at 260nm. If the Absorbance values at 330nm are below 0.020Abs, the measurements are considered valid.

- If the measured values are within the required tolerances, the **Passes Test** icon will be displayed. Press the button adjacent to the **Forwards Arrow** icon, to continue to measure a second application of calibration solution, or press the button adjacent to the **Cross** icon to abort the calibration process.

If the measured values are not within the required tolerances, the **Fails Test** icon is shown with an error number. Refer to section 11 for a list of error codes.

Press the button adjacent to the **Circular Arrow** icon to repeat the 1st calibration solution measurement or press the button adjacent to the **Back Arrow** icon to return to the blank solution measurement screen.

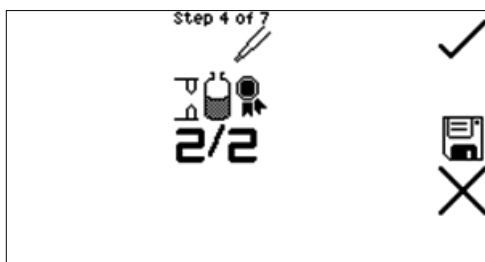

10. The **Calibration Solution Measurement** icon will be displayed for a second time. Open the instrument lid and use a lint free cloth to clean the read heads.

11. Pipette a 2.0µl aliquot of the calibration solution onto the lower read head. Close the instrument lid and press the key adjacent to the **Tick** icon to initiate the calibration solution measurement.

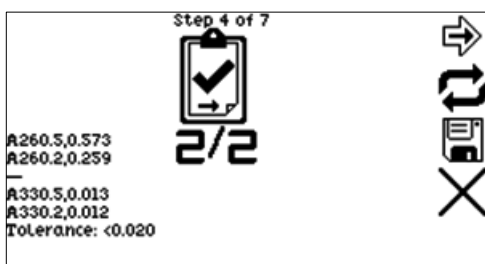

12. The unit takes three readings at 260 and 330nm, at both 0.5mm and 0.2mm path lengths. At the end of the readings, the unit will display the results of the measurements taken:

13. If the measured values are within the required tolerances, the **Passes Test** icon will be displayed. Press the button adjacent to the **Forwards Arrow** icon, to continue, or press the button adjacent to the **Cross** icon to abort the calibration process.

If the measured values are not within the required tolerances, the **Fails Test** icon is shown with an error number. Refer to section 11 for a list of error codes.

Press the button adjacent to the **Circular Arrow** icon to repeat the 2nd calibration solution measurement or press the button adjacent to the **Back Arrow** icon to return to the 1st calibration solution measurement screen.

If the forwards arrow is pressed the instrument compares the two sets of calibration solutions which have just been measured and ensures that the values are within 4% (+/-2%) of each other. If the two sets of measured values are not within this tolerance the **Fails Test** icon is shown with an error number. Refer to section 11 for a list of error codes.

14. The instrument will then display the pathlength factors for both 0.2mm and 0.5mm pathlengths.

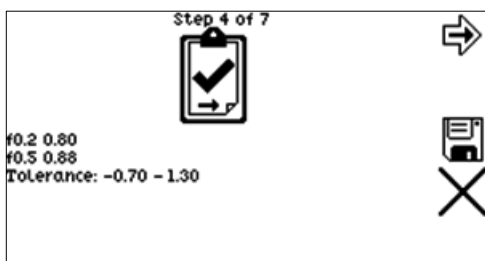

If the values displayed are within the tolerance range, the **Passes Test** icon will be displayed. Press the button adjacent to the **Forwards Arrow** icon, to continue, or press the button adjacent to the **Cross** icon to abort the calibration process.

If the measured values are not within the required tolerances, the **Fails Test** icon is shown with an error number. Refer to section 11 for a list of error codes.

Press the button adjacent to the **Circular Arrow** icon to repeat the 2nd calibration solution measurement or press the button adjacent to the **Back Arrow** icon to return to the 1st calibration solution measurement screen.

15. The new calibration factor values must now be verified by re-measuring the air, blank and standard values.

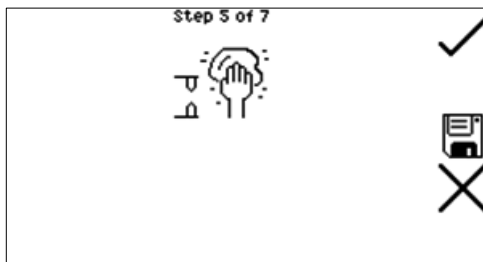

16. The **Air Measurement** icon will be displayed. Open the instrument lid and use a lint free cloth to clean the read heads. Close the instrument lid and press the key adjacent to the **Tick** icon to initiate the air measurement.

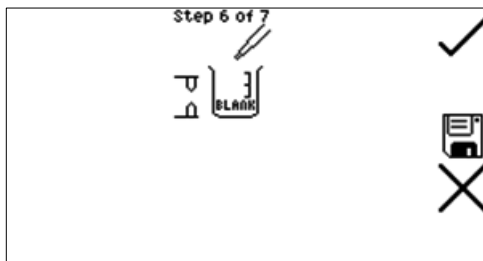

17. The unit takes two dark and light readings at 260 and 330nm, at both 0.5mm and 0.2mm path lengths.

18. The **Blank Solution Measurement** icon will be displayed. Open the instrument lid and pipette a 2.0µl aliquot of the matrix blank solution onto the lower read head. Close the instrument lid and press the key adjacent to the **Tick** icon to initiate the blank measurement.

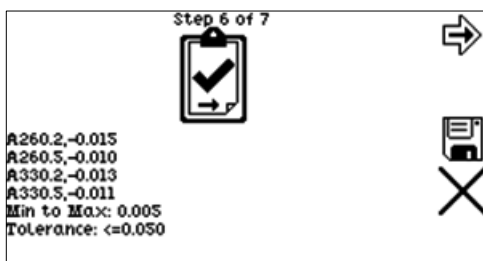

19. The unit takes two readings at 260 and 330nm, at both 0.5mm and 0.2mm path lengths. At the end of the readings, the unit will display the results of the measurements taken:

20. If the measured values are within the required tolerances, the **Passes Test** icon will be displayed. Press the button adjacent to the **Forwards Arrow** icon, to continue, or press the button adjacent to the **Cross** icon to abort the calibration process.

If the measured values are not within the required tolerances, the **Fails Test** icon is shown with an error number. Refer to section 11 for a list of error codes.

Press the button adjacent to the **Circular Arrow** icon to repeat the blank solution measurement or press the button adjacent to the **Back Arrow** icon to return to the air measurement screen.

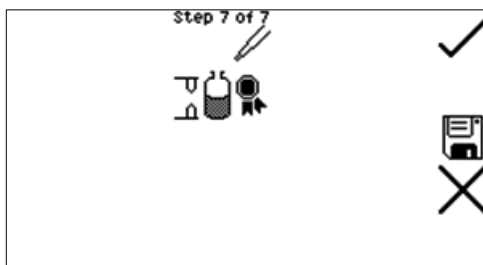

21. The **Calibration Solution Measurement** icon will be displayed. Open the instrument lid and use a lint free cloth to clean the read heads. Open the instrument lid and pipette a 2.0µl aliquot of the calibration solution onto the lower read head. Close the instrument lid and press the key adjacent to the **Tick** icon to initiate the calibration solution measurement.

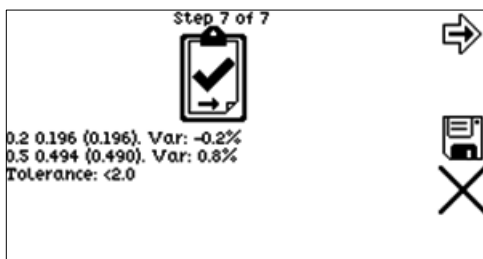

22. The unit takes two readings at 260 and 330nm, at both 0.5mm and 0.2mm path lengths. The variation from the expected Absorbance values are displayed.

23. If the measured values are within the required tolerances, the **Passes Test** icon will be displayed. Press the button adjacent to the **Forwards Arrow** icon, to continue, or press the button adjacent to the **Cross** icon to abort the calibration process.

If the measured values are not within the required tolerances, the **Fails Test** icon is shown with an error number. Refer to section 11 for a list of error codes.

Press the button adjacent to the **Circular Arrow** icon to repeat the calibration solution measurement or press the button adjacent to the **Back Arrow** icon to return to the blank solution measurement screen.

24. Following successful calibration, the instrument display will return to the micro volume accessory settings screen and the new path length calibration factors will be shown.

SECTION 8 – CLEANING AND DECONTAMINATION

8.1 CLEANING

Wiping the sample from both the upper and lower read heads upon completion of each sample measurement with a lint free cloth is usually sufficient to prevent sample carryover and avoid residue buildup. Although generally not necessary, water aliquots can be used to clean the measurement surfaces after the measurement of particularly highly concentrated samples to ensure no residual sample is retained on either read head. After measuring a large number of samples, it is recommended that the areas around the upper and lower pedestals are cleaned thoroughly. This will prevent spread of contamination from previous samples onto the measurement pedestals which could affect subsequent low-level measurements. A final cleaning of all surfaces with deionised water is also recommended after the last measurement.

8.2 DECONTAMINATION

If decontamination is necessary, a sanitising solution, such as a 0.5% solution of sodium hypochlorite (1:10 dilution of common commercial bleach solutions – freshly prepared), can be used to ensure that no biologically active material is present on the measurement read heads. The read head fittings are made from stainless steel and are resistant to most common laboratory solvents. See Section 13 - Chemical Compatibility for full details.

8.3 READ HEAD RECONDITIONING

Reagents containing surfactants can “un-condition” the measurement read head surfaces so that the liquid does not form a stable sample droplet. If this occurs, “buff” the read head surfaces by rubbing each measurement surface aggressively with a dry laboratory wipe 30-40 times. This will “re-condition” the surface allowing the sample droplet to form.

SECTION 9 – ACCESSORIES

9.1 ACCESSORIES

Part Code	Description
035 092	Calibration solution set

SECTION 10 – MAINTENANCE AND SERVICE

10.1 ROUTINE MAINTENANCE

Ensure the external surfaces of the unit are clean and free from dust. The sample area should always be kept clean and any accidental spillage should be wiped away immediately.

10.2 SERVICE

Our dedicated service team are on hand to help in the unlikely event that your Jenway equipment develops a fault. Please contact them by one of the following means stating the serial number of the unit and a clear description of the problem:

E-mail: cpSERVICE@coleparmer.com

Tel: +44 (0) 1785 810475

On occasion it may be necessary for your equipment to be sent back to our Service Department for repair. In this case please contact the Service Department for a reference number which you should include with your faulty equipment. Please also ensure you include a clear description of the fault and a completed copy of our Decontamination Certificate. Please clearly mark the package for the attention of the Service Department and post to the following address:

Cole-Parmer Ltd.
Beacon Road,
Stone,
Staffordshire,
ST15 0SA,
United Kingdom

All replacement parts are guaranteed for 1 year and wherever possible, returned equipment is turned around in 10 working days.

10.3 WARRANTY

Cole-Parmer Ltd. warrants this instrument to be free from defects in material and workmanship, when used under normal laboratory conditions, for a period of 3 years. In the event of a justified claim Cole-Parmer will replace any defective component or replace the unit free of charge. This warranty does NOT apply if damage is caused by fire, accident, misuse, neglect, incorrect adjustment or repair, damage caused by incorrect installation, adaptation, modification, fitting of non-approved parts or repair by unauthorised personnel.

Cole-Parmer Ltd,
Beacon Road,
Stone,
Staffordshire,
ST15 0SA,
United Kingdom

Email: cpSERVICE@coleparmer.com

Tel: +44 (0)1785 810475







Web: www.jenway.com

SECTION 11 – TROUBLESHOOTING

11.1 CALIBRATION ERROR CODES

If an error code is displayed during calibration it will be accompanied by a **Clipboard** icon and a number to indicate the cause of the error. The first time that an error is displayed, it will be possible to repeat the erroneous measurement. If the same error message is shown after the repeat measurement, the complete calibration process will need to be repeated. The table below shows the error codes:

11.1.1 Calibration Procedure Error Codes

Error Code	Symbol	Issue
1	 1	Absorbance range of calibration blanking solution for calibration steps is too large
2	 2	Background absorbance (330nm) of calibration solution is too large (first calibration solution)
3	 3	Background absorbance (330nm) of calibration solution is too large (second calibration solution)
4	 4	Variance in pair of calibration solution results is too large
5	 5	Calculated calibration pathlength factors are too large
6	 6	Absorbance range of calibration blanking solution for verification steps is too large
7	 7	Calibrated verification absorbances are outside of acceptable limits

11.2 TROUBLESHOOTING GUIDE

Issue	Solution
Unable to achieve zero absorbance or 100% transmittance when calibrating	Ensure that there is not a sample on the micro volume accessories read head. Ensure the instrument lid is closed before and during the calibration. Ensure the lamp is working – if the lamp has failed please request service assistance.
Unable to achieve a reading when measuring a sample	Ensure the correct path length is being used. Ensure the sample isn't so dense so that light is not transmitted through the sample. Ensure the lamp is working.



















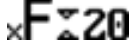







11.3 TECHNICAL SUPPORT

Jenway have a dedicated Technical Support team made up of experienced scientists who are on hand to help with any applications advice and questions you may have about our products or how to use them. If you require any technical or application assistance please contact the team at:

E-mail: cptechsupport@coleparmer.com

Phone: +44 (0)1785 810433

SECTION 12 – GLOSSARY OF ICONS

Error Code	Symbol	Issue
Common		Back key
Common		Tick icon - Done/yes
Common		Cross icon – Cancel/no
Common		Arrow icon – Move down, decrease
Common		Arrow icon – Move up, increase
Common		Arrow icon – Move forwards
Common		Arrow icon – Move backwards
Common		Results multiplied by 50 to normalise to a 10mm pathlength
Common		Results multiplied by 20 to normalise to a 10mm pathlength
Settings	 	0.2mm path length setting / selected
Settings	 	0.5mm path length setting / selected
Settings	 	Auto path length setting / selected
Settings		Path length calibration
Settings		260nm Calibration standard absorbance value
Settings		330nm Calibration standard absorbance value
Settings		Calibration standard path length value
Settings		Micro volume alignment
Calibration		Air measurement
Calibration		Blank solution measurement
Calibration		Calibration solution measurement
Calibration		Passes test
Calibration		Fails test
Calibration		Circular arrow icon
Calibration		Save calibration data icon

SECTION 13 – CHEMICAL COMPATABILITY

Assay	Chemical	Concentration
BCA	Sodium bicinchoninate	1%*
BCA	Sodium carbonate	2%*
BCA	Sodium tartrate	0.16%*
BCA	Sodium hydroxide	0.1M*
BCA	Sodium bicarbonate	0.95%*
BCA	Copper (II) sulphate	0.08%
Biuret	Sodium potassium tartrate	0.9%*
Biuret	Copper (II) sulphate	0.3%*
Biuret	Potassium iodide	0.5%*
Biuret	Sodium hydroxide	0.08M
Lowry	Sodium carbonate	1.6%
Lowry	Copper (II) sulphate	0.032%
Lowry	Sodium potassium tartrate	0.016%
Lowry	Sodium dodecyl sulphate	0.08%
Lowry	Sodium hydroxide	0.08M
Lowry	Folin reagent (lithium and sodium molybdotungstophosphate solution)	0.04N*
Bradford	Coomassie brilliant Blue G-250	0.01%*
Bradford	Ethanol	4.75%*
Bradford	Phosphoric acid	8.5%*
Bradford	Sodium hydroxide	0.1M
	DMSO	10%
	Acetonitrile	OK
	Methanol	OK
	2-Propanol	OK

*Highest concentration

SECTION 14 - DECLARATION OF CONFORMITY

CE This product meets the applicable harmonised standards for radio frequency interference and may be expected not to interfere with, or be affected by, other equipment with similar qualifications. We cannot be sure that other equipment used in its vicinity will meet these standards

and so we cannot guarantee that interference will not occur in practice. Where there is a possibility that injury, damage or loss might occur if equipment malfunctions due to radio frequency interference, or for general advice before use, contact the manufacturer.

JENWAY

 Cole-Parmer®

EU Declaration of Conformity

Product	Laboratory Equipment	File Number	P225
Manufacturer	Cole-Parmer Ltd Beacon Road Stone, Staffordshire ST15 0SA United Kingdom		

This declaration of conformity is issued under the sole responsibility of the manufacturer

Object of Declaration UV-Visible Spectrophotometer Range - 73 Series
(reference the attached list of catalogue numbers)

The object of the declaration described above is in conformity with the relevant Union Harmonisation Legislation:

Low Voltage Directive	2006/95/EC
EMC Directive	2004/108/EC
RoHS Directive	2011/65/EC

References to the relevant harmonised standards used or references to the other technical specifications in relation to which conformity is declared:

EN 61010-1:2001	Safety requirements for electrical equipment for measurement, control and laboratory use. Part 1: General requirements.
EN 61326-1:2006	Electrical equipment for measurement, control and laboratory use. EMC requirements. Part 1: General requirements (Class A).

Signed for and on behalf of the above manufacturer

Additional Information Year of CE Marking: 2010

Place of Issue Stone, Staffordshire, UK

Date of Issue April 2010. Revised 15 July 2012

Authorised Representative Steve Marriott

Title Technical Director

Signature 

Declaration of Conformity is also available to view online at www.jenway.com



Cole-Parmer Ltd.

Beacon Road,
Stone,
Staffordshire,
ST15 0SA,
United Kingdom
Tel: +44 (0)1785 812121
Email: cpinfo@coleparmer.com
Web: www.jenway.com